

R2600 / R2601

Electronic Controller

3-348-778-15
6/6.03

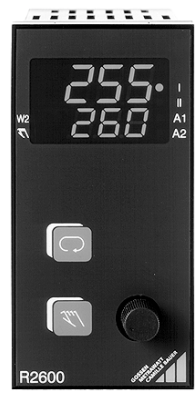

CONTENTS

	Page
Safety features and safety precautions	4
Maintenance	5
Repair and replacement parts service	5
Identifying the unit	6
Physical installation / Getting started	8
Electrical connection	10
Configuring the switching outputs I and II	12
Behavior when the auxiliary voltage is switched on	12
Operation	13
Operational flow diagram „Switching controller“	14
Operational flow diagram „Switching controller“ for diff. controller ...	15
Operational flow diagram „Continuous and step controller“	16
Operat. flow diag. „Cont. and step controller“ for diff. controller	17
Off / manual mode	18
Manual mode with binary input 2	19
Feedforward control with binary input 2	19
Configuration	20
Storage and Uploading of Device Settings	23
Differential controller	24
Slave controller	24
Controller types	25
Configuration of the controller with continuous output (marking A3) ..	26
Setting parameters	28

Page

CONTENTS

	Page
Calibration	30
Self-optimizing	31
Manual optimizing	32
Set point ramps	36
Heating current monitor	36
Heating circuit monitor	37
Limit monitor	38
Alarms	39
Error messages	40
Technical data	42

Page

Meaning of the symbols on the unit



EC conformity marking



Double or reinforced all-insulation



Warning of danger
Attention: see documentation

Instrument approval



CSA approval mark

Safety features and safety precautions

The R2600 / R2601 controller is constructed and tested in compliance with the safety rules of IEC 1010-1 / VDE 0411-1. When properly used, the safety of both the user and the unit is assured.

**Read the operating instructions carefully and completely before you use your unit. Follow them in all respects.
Make the operating instructions accessible to all users.**

Please note the following safety precautions:

- The controller must only be connected to a line corresponding to the nominal range of use (see connection diagram and nameplate) which is fused for a maximum nominal current of 16 A.
- A switch or a power switch must be provided in the installation as isolating device.

The controller must not be used:

- When the exterior shows obvious signs of damage
- When it no longer functions correctly
- After prolonged storage under adverse conditions (e.g. moisture, dust, temperature).

In such cases, take the controller out of service and secure it against accidental use.

Maintenance

Case

Special maintenance of the case is not required. Take care that the surface is clean. Use a slightly moist cloth for cleaning. Do not use solvents, detergents and scouring agents.

Repair and replacement of parts

Repair or replacement of parts with the tester open and alive must only be performed by a skilled person which is familiar with the danger involved.

Repair and replacement parts service

When you need service, please contact:

GOSSEN-METRAWATT GMBH
Service-Center
Thomas-Mann-Straße 20
90471 Nuremberg, Germany
Phone +49 911 86 02 - 410 / 256
Fax +49 911 86 02 - 2 53
e-mail fr1.info@gmc-instruments.com

This address is only valid in Germany. In other countries our representative or subsidiaries may be contacted.

Identifying the unit

Electronic controller	with self-optimizing facility, second set point, 2 limit relays, front dimensions 48 x 96 mm (W x H)			R2600	
Electronic controller	with self-optimizing facility, second set point, 2 limit relays, front dimensions 96 x 48 mm (W x H)				R2601
Controller type					
Two-state controller with heating current monitor		1 relay and 1 transistorized output		A1	
Three-state controller with heating current monitor / step controller		2 relay and 2 transistorized outputs		A2	
Contin. controller / three-state with heating curr. monitor / step controller		1 continuous, 2 transistorized and 2 relay outputs		A3	
Step controller with position read-back / three-state controller		2 relay and 2 transistorized outputs		A4	
Measuring ranges					
Signal input	Thermocouple, configurable	Type J, L	-18 ... 850 °C /	0 ... 1562 °F	B1
		Type K	-18 ... 1200 °C /	0 ... 2192 °F	
		Type S, R	-18 ... 1770 °C /	0 ... 3218 °F	
		Type B	0 ... 1820 °C /	32 ... 3308 °F (espec. from 600 °C)	
		Type N	-18 ... 1300 °C /	0 ... 2372 °F	
	Resistance thermometer	Pt 100	-100 ... 500 °C /	-148 ... 932 °F	
Signal input	Standard signal, configurable	0 / 2 ...	10 V or	0 / 4 ...	20 mA
Both signal inputs are <u>commonly</u> configurable same as B1 for differential controller					B3
B2 configurable for slave controller , signal input same as B1					B4
Both signal inputs configurable same as B2 for differential controller / slave controller					B5
Auxiliary voltage	AC 230 V	} C1 → C2 or C2 → C1 internal plug-change possible			C1
	AC 110 V				C2
	AC 24 V				C3
	DC 24 V				C4

Connection plug	Connection from the side	D0
	Connection from the rear	D1
Data interface	None	F0
	RS 485 / RS 232 internal switch-over possible	F1
Configuration	Default setting	K0
	Setting as per customer's request	K9
Operating instructions	German / English	L0
	French / Italian	L1
	None	L2



Bild 1, Switch-over of auxiliary voltage C1 ↔ C2, serial interface RS 485 ↔ RS 232



When changing the aux. voltage setting, enter the correct voltage on the nameplate (plug-in module) and on the connection diagram (case)!

Data interface

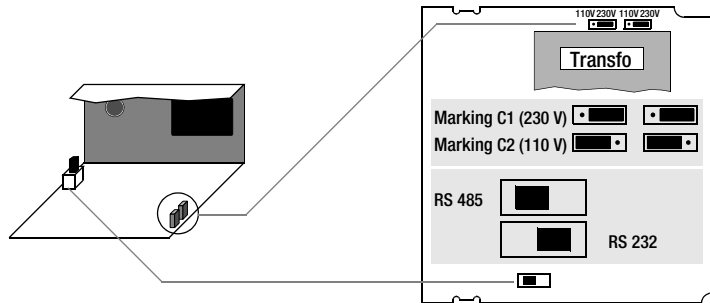
See operating instructions
No. 3-348-518-15
for more information
on the data interface

Physical installation / Getting started

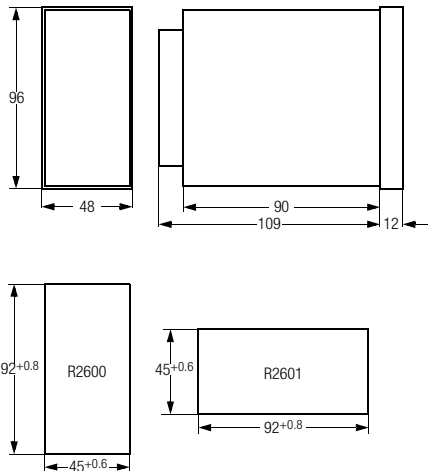

The R2600 / R2601 is meant for panel installation. As far as possible, the mounting site should be free from vibrations. Aggressive vapors reduce the service life of the controller. Observe the VDE 0100 specifications when performing any work. Work on the controller must only be performed by a qualified person who is familiar with the danger involved.

From the front, insert the case into the cutout and from the rear, fasten it at the top and bottom with the two screw clamps supplied. The typical starting torque is 10 Ncm and should not exceed 20 Ncm.

Side-by-side mounting of several units is possible without intermediate bars. The supplied seals for maintaining protection class IP54 cannot be used in this case. Protection class IP54 is only assured in the case of a sunk rotary button.

When installing one or more units, it is a general requirement to provide for unobstructed air circulation. The ambient temperature below the units must not exceed 50 °C.

Withdrawing the instrument module (e.g. for setting of the DIP switch):

- Hold the instrument module on the front at tray and diaphragm between thumb and forefinger (the pressure exerted on the diaphragm unlocks the plug-in module)
- Pull strongly

Bild 2, Case dimensions and panel cutout

**Locking the two screw clamps
(R2600 upper and lower side of case,
R2601 right and left side of case):**

- Slide in direction **1** up to the stop
- Slide in direction **2** up to the stop



R2600: View of lower side of case



R2601: View of right side of case

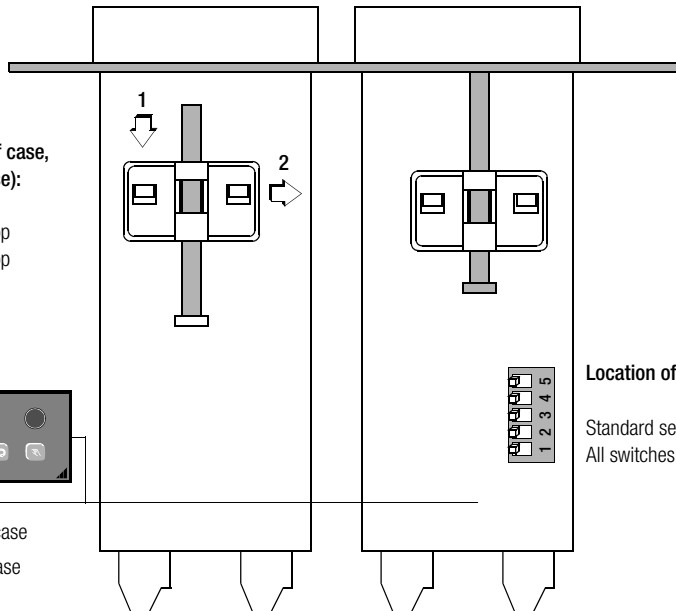

Location of the 5-pin DIP switch

Standard setting:



All switches "off" (switch lever up)

Bild 3, Case fasteners and location of the DIP switch

Connection elements: Screw terminals for 2.5 mm² stranded wire and/or double multicore cable ends for 2 × 1.0 mm²



Bild 4, Location of the connection contacts

Configuring the switching outputs I and II

With marking A3 and the use of a transistorized output, the continuous output must only be used as 10 V output (load $\geq 10 \text{ k}\Omega$).

Switching output I

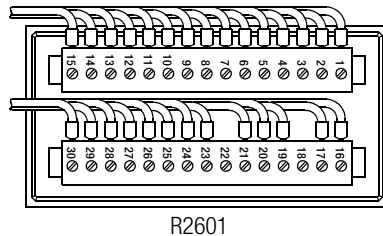
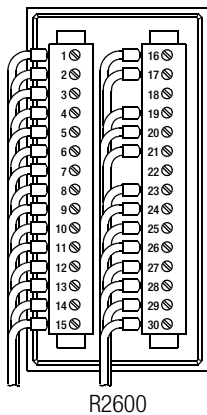

Relay



Transistorized output

Switching Output II

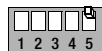

Relay

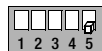

Transistorized output

Behavior when the auxiliary voltage is switched on

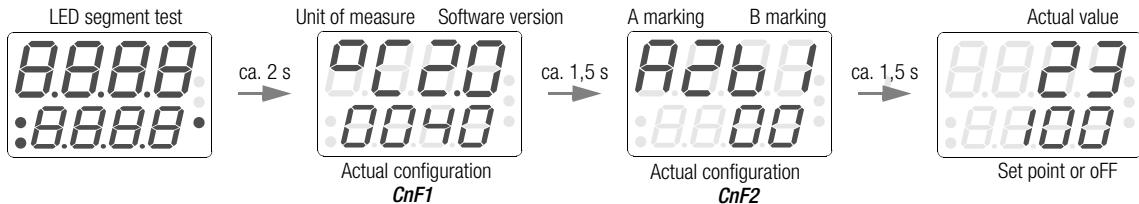

Operation

Bild 5, Operating controls (arrangement for R2601)

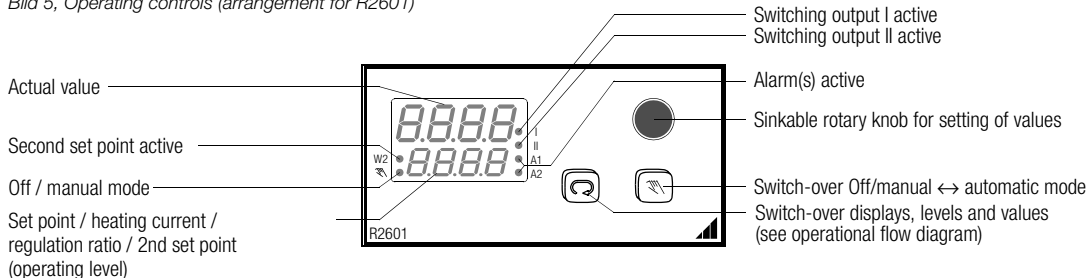

Setting of values with the rotary knob

- Slight turning does not change the value to be set at first (medium range of the rotating angle) to avoid an accidental change.
- When turning stronger to the left or right against the spring tension, the value is decremented or incremented for coarse setting the faster the knob is turned further (spring range).
- When the rotary knob is released, the spring range is left.
- After a change of the value in the spring range, vernier setting by approximately 5 digits is possible on the medium range.
- The value is stored and effective after 2.5 s or after a key stroke. This is signalled by a brief blanking of the display.

Operational flow diagram „Switching controller“

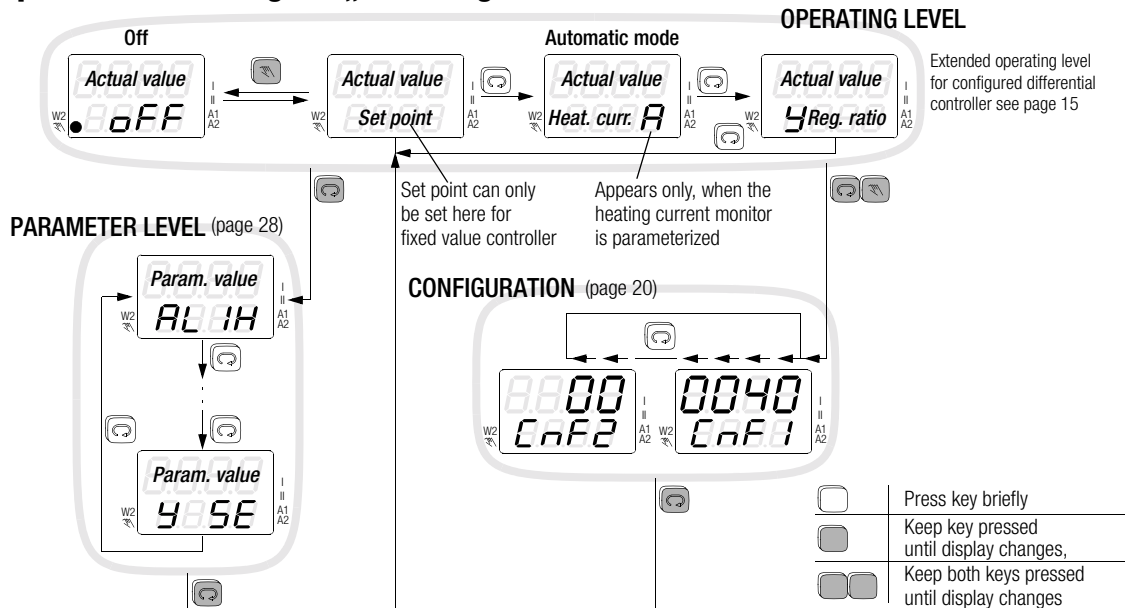

Operational flow diagram „Switching controller“ for differential controller

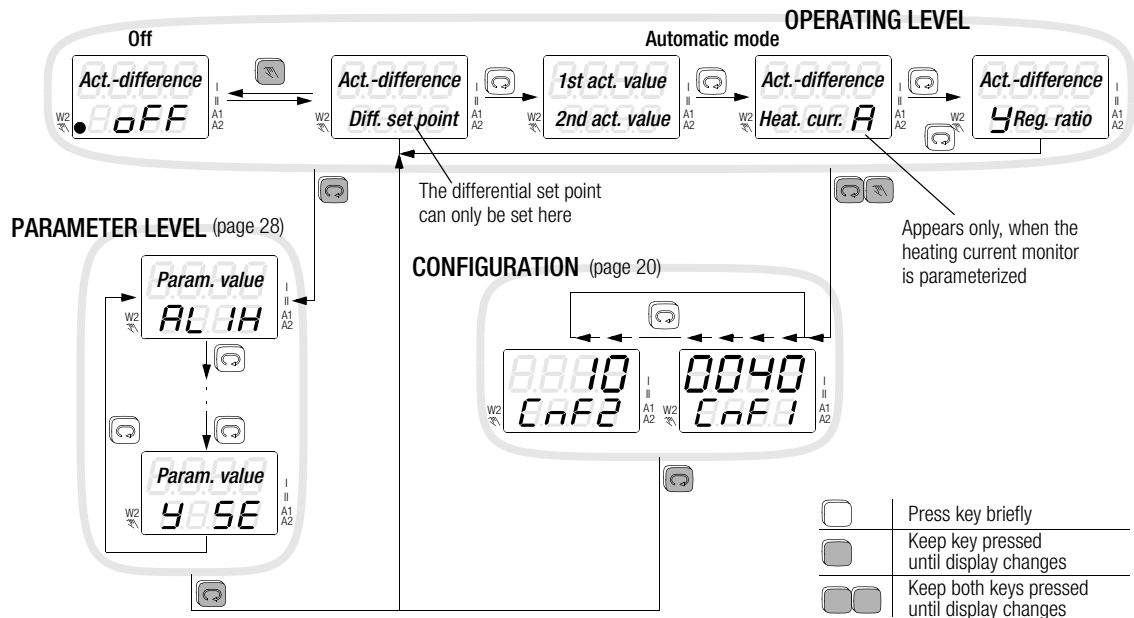

Operational flow diagram „Continuous and step controller“

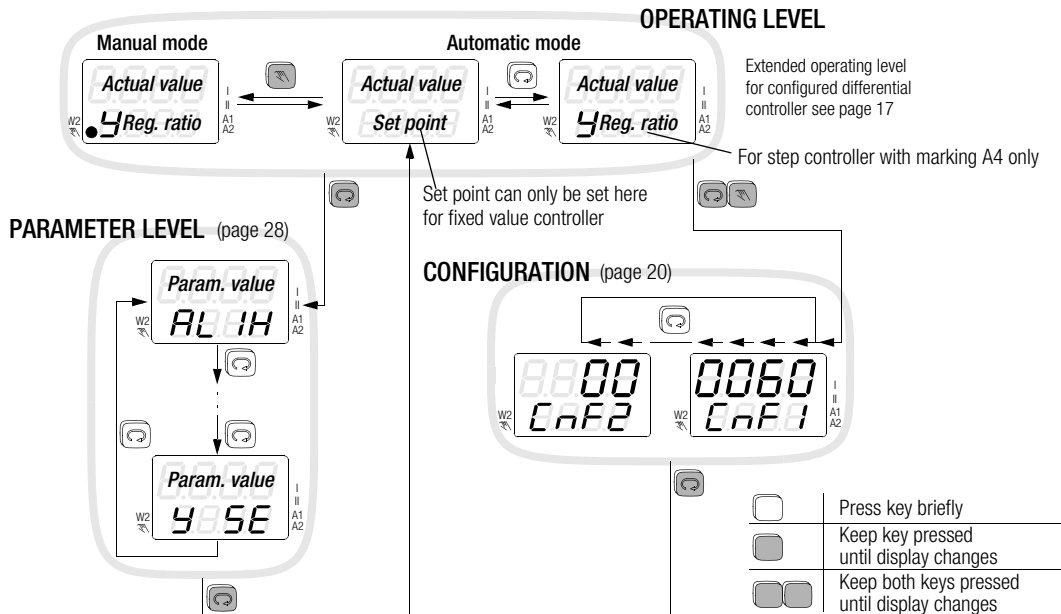

Operational flow diagram „Continuous and step controller“ for differential controller

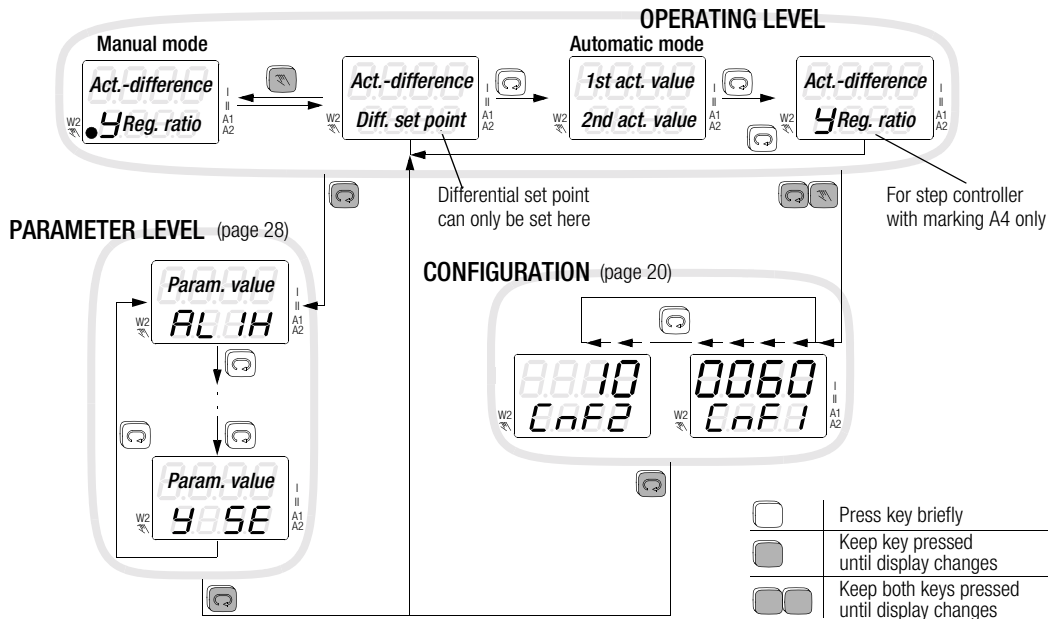

Off / manual mode

OPERATING LEVEL SWITCHING CONTROLLER

- No alarm function
- No error signalling

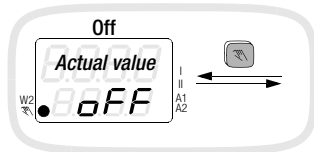

- The positioning outputs are inactive with the rotary knob not actuated.
- The switching output I ("heat") / II ("cool") is directly controlled by turning the knob to the right / left into the spring range

- Alarm function and error signalling same as with automatic mode.
- The positioning outputs are not controlled by the controller function but by the rotary knob.
- Manual/automatic switch-over is bumpless in both directions.
- Continuous controller: The regulation ratio is shown in %. Changes in value are slow in the spring ranges of the rotary knob and are instantly passed to the control outputs.
- Step controller: The switching output I (more) / II (less) is directly controlled by turning the knob to the right/left into the spring range. With position readback available (marking A4), the measured position is shown in % while lines are shown with marking A2, A3.

OPERATING LEVEL CONTINUOUS AND STEP CONTROLLER

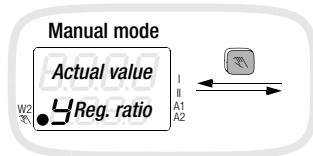

Manual mode with binary input 2

The controller can be switched to manual operation with binary input 2.

This is distinguished from the Off / manual mode with the  key.

- Bumpless change-over to manual mode for **all** controller types.
- The last regulation ratio is „frozen“ also on switching controllers.
- With limit monitor, the last switching state is maintained.
- Operation and display are the same as in automatic mode with the exception that the LED  lights and the regulation ratio in the display can be changed with the rotary knob.
- Parameter **Y St** must be set to 0 during configuration as a discontinuous or a continuous action controller (controller types 2 through 5).

Feedforward control with binary input 2

During configuration as a discontinuous or a continuous action controller (controller types 2 through 5), control quality can be markedly improved by means of feedforward control if large, sudden load changes occur.

- When the contact at binary input 2 is closed, the extent of regulation provided by the controller is increased by value **Y St**.
- If the contact is opened, this value is reduced by the same amount again.
- No function when self-optimization is activated
- If **Y St** is set to 0, binary input 2 activates manual operation, (see above).

Example: If a heating unit in a machine needs to be run at an average of 70% power during production, but only at 10% during idle-time, differential value **Y St** is set to 60%, and binary input 2 is only activated during production.

Configuration

(Cont'd on page 22)

Controller type		Condition
Code		
0	Limit monitor	
1	Positioner	
2	Two-state controller Heat *)	
3	Two-state controller Cool *)	
4	Three-state controller *)	Not for marking A1
5	Three-state contr. Water cooling	
6	Step controller	

*) See page 26 for setting of continuous controller

Alarms 1				
Code		Startup suppression	Contact	Heating circuit monitor
0	Relative	Inactive	NOC	Inactive
1	Absolute			
2	Relative	Active		
3	Absolute			
4	Relative	Inactive	NCC	Inactive
5	Absolute			
6	Relative	Active		
7	Absolute			
8	Relative	Inactive	NOC	Active
9	Absolute			
A	Relative	Active		
b	Absolute			
C	Relative	Inactive	NCC	
d	Absolute			
E	Relative	Active		
F	Absolute			

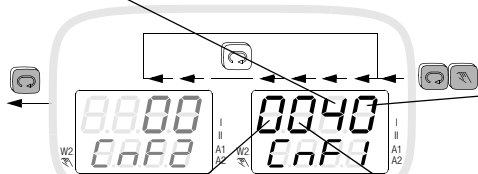

	Unit of measure ¹⁾ of the sensor / continuous output ²⁾		
Code	Unit meas. ¹⁾	Output range ²⁾	Output quantity ²⁾
0	°C	0 ... 20 mA	Actual value (switching controller)
<i>1</i>	°F	0 ... 10 V	
2	°C	4 ... 20 mA	
3	°F	2 ... 10 V	Regulation ratio (continuous controller)
4	°C	0 ... 20 mA	
<i>5</i>	°F	0 ... 10 V	
6	°C	4 ... 20 mA	Select output quantity <i>Cont</i> (see page 27)
<i>7</i>	°F	2 ... 10 V	
8	°C	0 ... 20 mA	
<i>9</i>	°F	0 ... 10 V	Select output quantity <i>Cont</i> (see page 27)
A	°C	4 ... 20 mA	
<i>b</i>	°F	2 ... 10 V	
<i>c</i>	(no function)		
<i>d</i>	 Storage and downloading of device settings see page 23		
<i>E</i>			
<i>F</i>			

1) Change-over °C / °F effective only with marking B1, B3 and B4

2) Only effective with marking A3

	Sensor type		
Code	Type	Kind	Condition
0	J	Thermo- couple	For signal input 1 with marking B1, B4
<i>1</i>	L		
2	K		
3	B		
4	S		For both signal inputs with marking B3
5	R		
6	N	Pt 100	
7	1 ° display		
<i>8</i>	0.1 ° display	Stand. signal	For signal input 1 with marking B2, B5
0	0 ... 20 mA / 0 ... 10 V		
<i>1</i>	4 ... 20 mA / 2 ... 10 V		

Configuration disabled with DIP switch
set as shown and during self-optimizing
Configuration enabled with DIP switch
set as shown

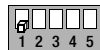

Highlighted: default setting KO

Configuration (Cont'd)

Code	Function signal input 2			Standard signal 2 B4, B5
	B3	B4	B5	
0	Fixed value controller (internal set point)			0 ... 20 mA 0 ... 10 V
1	Diff. controller	Fixed value contr.	Diff. controller	
2	–	Slave controller		
3	–			
4	–	Fixed value controller		4 ... 20 mA 2 ... 10 V
5	–	Fixed value contr.	Diff. controller	
6	–	Slave controller		
7	–			

Code	Alarms 2		
		Startup suppression	Contact
0	Relative	Inactive	NOC
1	Absolute		
2	Relative	Active	
3	Absolute		
4	Relative	Inactive	NCC
5	Absolute		
6	Relative	Active	
7	Absolute		

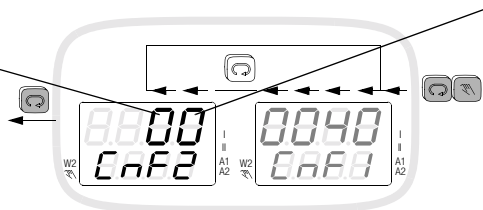

Storage and Uploading of Device Settings

Code	Function	 Note
<i>d</i>	The current setting ¹⁾ is stored as a user defined default setting.	Configuration according to customer specifications (K9) is stored in this location and is thus overwritten. All entries are overwritten, including the results of self-optimization and calibration.
<i>E</i>	The user defined default setting is uploaded ¹⁾ . If a setting has never previously been stored with <i>d</i> , the factory default setting, or the configuration in accordance with customer specifications (K9), is uploaded.	
<i>F</i>	The factory default setting ¹⁾ is uploaded.	

1) Configuration digits and all parameters except for the interface address **Addr**.

Differential controller

See page 28 for *Parameters*

- The actual value difference = 1st actual value – 2nd actual value is controlled to the set differential set point.
- The differential set point can be set on the range \pm range span.
- Limit monitoring is referred to the difference in actual values and not the two actual values.
- If an attempt is made to adjust the differential set point on the operating level, display mode 1st actual value / 2nd actual value, by means of the potentiometer, **no** is briefly shown on the lower display.

Slave controller

See page 28 for *Parameters*

- The external set point applied to the 2nd signal input replaces the internal set point.
- The set point ramp function (see page 36) is maintained.
- When switching over to the second set point by means of a binary input, the controller becomes a **fixed value controller** with the set point **SP 2**.
- The lower and upper limit of the external set point is scaled by means of the parameters **rn L** and **rn H** (2nd standard signal for B4 and B5).
- The parameters **SP L** and **SP H** limit the external set point for control and display.
- If an attempt is made to adjust the set point on the operating level, display mode actual value / set point, by means of the potentiometer, **no** is briefly shown on the lower display.

Controller types

See page 28 for *Parameters*

Code	Controller Type	Remarks
0	Limit monitor	Switching output I is active, if act. value < actual set point, switching output II is active, if actual value > actual set point + dbnd . The switching hysteresis is HYST . A change of the switching state can be made every tc .
1	Positioner	Output of a constant positioning signal to switching output I, if YST > 0, to switching output II, if YST < 0. The positioning cycle is tc . No alarm functions.
2	2-state controller „Heat“	A PDPI control algorithm without overshoot controls the switching output I in order to increment / decrement the actual value. The positioning cycle is at least tc .
3	2-state controller „Cool“	A PDPI control algorithm without overshoot controls the switching output I in order to increment the actual value and/or the switching output II to decrement the actual value. The positioning cycle is at least tc . The deadband dbnd suppresses a change between "Heat" and "Cool", without offset.
4	Three-state controller	The regulation ratio of the switching output II is matched to the non-linear behavior of a water cooler. The positioning cycle is tc .
5	Three-state controller Water cooling	A PDPI control algorithm without overshoot controls the switching output I and/or II in order to increment/decrement the actual value. The positioning pulse width is tc . The deadband dbnd is symmetric to the set point.
6	Step controller	

Configuration of the controller with continuous output (marking A3)

Continuous output = actual value (configuration digit „Unit of measure of the sensor / continuous output“ = 0, 1, 2, 3)

- The controller types act as with marking A2.
- The output of the actual value (for different controllers diff. between actual values) is scaled with parameters *rn L* and *rn H*.

Continuous output = regulation ratio (configuration digit „Unit of measure of the sensor / continuous output“ = 4, 5, 6, 7)

- The switching output I is inactive.
- The different types of continuous controllers result from the configuration digit „Controller type“:



Code	Controller type	Remarks
0	Limit monitor	Output of a regulation ratio adjustable with parameter <i>Y H</i> , if actual value < set point
1	Positioner	Output of a regulation ratio adjustable with parameter <i>Y St</i> .
2	Cont. contr. with falling characteristics	A PDPI control algorithm without overshoot controls the continuous output every 0.5 s.
3	Cont. contr. with rising characteristics	An output filter provides for as smooth a trend of the positioning signal as possible. The time constant of an additional actual value is set by means of <i>tc</i> .
4	Split range controller	Continuous controller with falling characteristics for positive regulation ratios (increment set point). Negative regulation are output with switching output II (decrement set point). The positioning cycle for switching output II is at least <i>tc</i> . The deadband <i>dbnd</i> suppresses a quick change between continuous output and switching output II, without offset.
5, 6		No practice-relevant function

Continuous output = “select with *Cont*” (configuration digit “Unit of measure of the sensor / continuous output” = 8, 9, A, b)

<i>Cont</i>	Contin. output	Remarks
<i>0</i>	actual set point	The output is scaled with the parameters <i>mL</i> and <i>mH</i> (with differential controller the actual value difference). The controller types act same as with marking A2.
<i>1</i>	„Cool“ reg. ratio	Negative regulation ratios are continuously output, the switching output II remains inactive. Controller type = 4: corresponds to split-range controller with inverted output action.

Setting parameters

X1 = lower range limit, X2 = upper range limit, MBU (range span) = X2 – X1

Parameter	Display	Range	Default	Remarks	
High limit for relay A1	<i>AL IH</i>				Parameter disabled at DIP switch position shown 
Low limit for relay A1	<i>AL IL</i>	oFF, 1 ... MBU	oFF	Relative (= standard config.)	
High limit for relay A2	<i>AL 2H</i>	oFF, X1 ... X2	oFF	Absolute	
Low limit for relay A2	<i>AL 2L</i>				
Second set point	<i>SP 2</i>	<i>SPL ... SPH</i>	X1		
Ramp for rising set points	<i>SP uP</i>	oFF, 1 ... MBU per min	oFF		
Ramp for falling set points	<i>SP d n</i>	oFF, 1 ... MBU per min	oFF		
Set point of the heat. curr. (see calibr.)	<i>ANPS</i>	Auto, oFF, 0.1 ... <i>A H</i>	oFF	Not for step controller ¹⁾	
Proportional band Heat	<i>Pb I</i>	0.1 ... 999.9 %	10.0		Parameter disabled at DIP switch position shown 
Proportional band Cool	<i>Pb II</i>	0.1 ... 999.9 %	10.0	For three-state controller ²⁾	
Deadband	<i>dbnd</i>	0 ... MBU	0	Not for 2-state controller ³⁾	
Delay time of the controlled system	<i>t u</i>	0 ... 9999 s	100		
Cycle output time	<i>t c</i>	0.5 ... 600.0 s	10.0	⁴⁾	and during self-optimizing
Motor running time	<i>t y</i>	5 ... 5000 s	60	For step controller only ⁵⁾	
Switching hysteresis	<i>HYS t</i>	0 ... 1.5% MBU	0,5% MBU	for limit value monitoring and limit monitor	

High set point	<i>SP H</i>	<i>SPL</i> ... X2	X2		
Low set point	<i>SP L</i>	X1 ... <i>SPH</i>	X1		
Maximum regulation ratio	<i>y H</i>	-100 ... 100 %	100	0 ... 100 with marking A1	
Act. value calibr. (see Calibration)	<i>CAL</i>	(Auto), -MBU/4 ... +MBU / 4	0	only with marking B1, B3, B4	
Location of decimal point	<i>dPnt</i>	9999, 999.9, 99.99, 9.999	9999	only with marking B2, B5	
Upper range limit standard signal	<i>rn H</i>	<i>rn L</i> ... 9999	100	only with marking B2 ... B5	Parameter disabled with DIP switch set as shown  and during self-optimizing
Lower range limit standard signal	<i>rn L</i>	-1500 ... <i>rn H</i>	0		
Upper range limit Heating current	<i>A H</i>	1.0 ... 99.9 A	42,7	Not for step controller 1)	
Calibration position readback	<i>y 100</i>	See Calibration		For step controller with position readback 6)	
	<i>y 0</i>				
Reg. ratio for actuator operation or for feedforward control	<i>y St</i>	-100 ... 100 %	0	0 ... 100 with marking A1	
Regulation ratio with sensor error	<i>y SE</i>	-100 ... 100 %	0	0 ... 100 with marking A1	
Continuous signal	<i>Cont</i>	see page 27	0	only with marking A3	
Interface address	<i>Addr</i>	0 ... 250	250	only with marking F1	

- 1) Only for: marking ≠ A4 and configuration digit „controller type“ ≠ 6
 2) Only for: marking ≠ A1 and configuration digit „controller type“ = 4 or 5
 3) Only for: marking ≠ A1 and configuration digit „controller type“ = 0, 4, 5 or 6
 4) Additional actual value filter for continuous action controller (controller type = 2.3). *tc* = time constant
 5) Only for: marking ≠ A1 and configuration digit „controller type“ = 6
 6) Only for: marking = A4 and configuration digit „controller type“ = 6

All parameters enabled at DIP switch position shown

Calibration

Thermocouple correction (parameter *CAL*)

This correction value is set in °C / °F. The correction value displayed is added to the measured temperature value.

Lead calibration with Pt 100 two-wire connection (parameter *CAL*)

The calibration can automatically be determined in "Off / manual mode".

- Short sensor **at** measuring **site**.
- Set *CAL* value to *Auto*

The lead resistance measured is converted into a temperature change and entered as *CAL* value.

If the sensor temperature is known, manual calibration is also possible: $CAL = \text{known sensor temperature} - \text{displayed temperature}$.

Scaling of the heating current monitor (parameter *A H*)

The standard setting for GTZ 4121 is 42.7 A. If the current transformer GTZ 4121 is not used to acquire the heating current, set the current value at which the transformer used provides 10 V DC.

Calibrating the position readback display (parameter *Y100*, *Y0*)

Calibration is made in manual mode on the parameter level at a configuration as step controller (configuration digit "controller type" = 6):

1. Select parameter *Y 100*, the stored value appears at first: a standardized value between 0 and 255.

The rotary knob, kept at the right stop, directly serves the switching output I (more) and the display shows the actually measured position of the control element. Keep the rotary knob at the right stop until the displayed value changes no longer. The displayed value is stored.

2. Select parameter *Y 0*.

Proceed same as for parameter *Y 100*. In this case, the rotary knob must be kept at the left stop. It directly serves the switching output II (less).

Y 100 must be higher than *Y 0*!

The parameters *Y 100* and *Y 0* are only displayed in automatic mode.

Self-optimizing

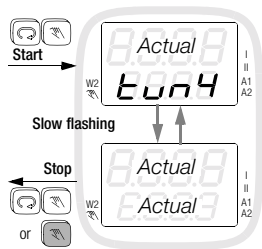

Self-optimizing serves to determine optimum control dynamics that is, the parameters *Pb I*, *Pb II*, *tu* and *tc* are determined.

Getting started

- Complete configuration must be made before self-optimizing is started
- The set point must be set to the value required after optimizing.

Start

- Self-optimizing is started when both keys on the operating level (automatic or manual/Off mode) are briefly pressed simultaneously. It cannot be started with the controller types "Positioner" or "Limit monitor"
- *tun1...tun8* is flashingly shown on all operating levels during the optimizing run
- When optimizing is successfully ended, the controller enters automatic mode.

- With a three-state controller (controller type = 4 and 5), cooling is activated when the high limit responds in order to prevent overheating. Self-optimizing then performs an oscillation test around the set point.

Procedure

- The actual set point at the start remains valid; it can no longer be changed (slave controller: a changing external set point is only displayed)
- Activation/deactivation of the second set point does not become effective
- Set set point ramps are not considered
- Overshooting cannot be avoided when starting in the working point (actual value corresponds nearly to set point)

Stop

- Optimizing can be stopped at any time with  (→ automatic mode) and/or by switching over to manual / Off with 
- Should an error occur while optimizing, the controller no longer issues a positioning signal. Optimizing must be stopped.

More information about error messages on request.

Self-optimizing is enabled when supplied (default setting K0). Disabling via DIP switch:



Manual optimizing

The parameters ***Pb I***, ***Pb II***, ***tu*** and ***tc*** are defined by manual optimizing to obtain optimum control dynamics. A trial run and an oscillation test is made for this purpose.

Getting started

- For the use of the controller, a **complete configuration** (page 20) and **parameter setting** (page 28) must first be made.
- The control elements should be deactivated by **Off / manual mode** (page 18).
- Connect a **recorder** to the sensor and set it in line with the dynamics of the controlled system and the set point.
The actual value difference must be recorded for the differential controller.
- For a three-state and/or split range controller it is required to record the On and Off time of the switching output I and/or the continuous output (e.g. with another recorder channel or with a timer).
- Configure the **limit monitors** (controller type Code = 0).
- Set the output cycle time to minimum: ***tc* = 0.5**.
- If possible, switch the limiter of the regulation ratio off: ***YH* = 100**.
- Lower (and/or raise) the **set point** so that the overshoots and undershoots will not take impermissible values.

Performance of a trial run

- Set ***dbnd* = MBU** for three-state and/or split range controller (switching output II must not respond).
Set ***dbnd* = 0** for step controller (switching output II must respond).
- Start the recorder.
- Activate the control elements in **automatic mode**.
- Record two overshoots and two undershoots. *Trial run ended for two-state, continuous and step controller.*
With three-state and/or split range controller proceed as follows:
- Set ***dbnd* = 0** to cause more oscillations with switching output II active, wait for two overshoots and undershoots.
- Record the **On time T_I** and the **Off time T_{II}** of the last shoot of the switching output I and/or the continuous output.

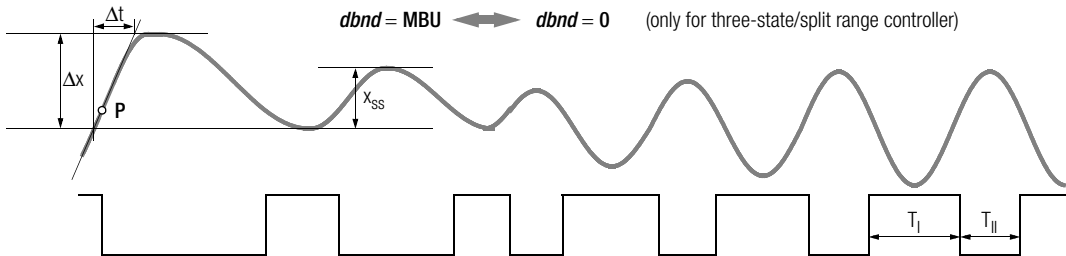

Evaluation of the trial run

- Apply a tangent to the curve at intersection P of actual value and set point and/or switch-off point of the output.
- Measure out time Δt .
- Measure out oscillation width x_{ss} , for step controller overshoot Δx .

	Parameter values				
<i>tu</i>	$1.5 \cdot \Delta t$			$\Delta t - (tY / 4)$	
<i>tc</i>	$tu / 12$			$tY / 100$	
<i>Pb I</i>	$(x_{ss} / MBU) \cdot 100 \%$		$(x_{ss} / MBU) \cdot 200 \%$		$(\Delta x / MBU) \cdot 50 \%$
<i>Pb II</i>	–	$Pb I \cdot (T_I / T_{II})$	–	$Pb I \cdot (T_I / T_{II})$	–
Parameter	Two-state controller	3-state controller	Contin. controller	Split range controller	Step controller

If a limitation was set for the set point, it is required to correct the proportional band

YH positive: Multiply **Pb I** by 100 % / **YH**

YH negative: Multiply **Pb II** by –100 % / **YH**

Performing an oscillation test

If it is not possible to perform a trial run, e.g. where adjacent control loops strongly influence the actual value, or where an active switching output is required to hold the actual value (working point of cooling), or where certain reasons require optimizing to the set point, the control parameters can be established by means of a continuous oscillation. However, the calculated values for **tu** could eventually be very inaccurate in this case.

- Get started as described above. It is possible to perform the test without a recorder, if the actual value is watched on the display and the times on a timer.
- Set **dbnd** = 0 for three-state, split range and step controllers.
- Activate the control elements in **automatic mode**, eventually start a recorder. Record several oscillations until they are alike.
- Measure out the **oscillation width** x_{ss} .
- Record the **On time** T_I and the **Off time** T_{II} of the switching output I and/or the continuous T_{II} output of the oscillations.

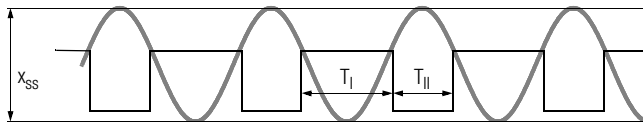

Evaluation of the oscillation test

	Parameter values				
$tu^{1)}$	$0.3 \cdot (T_I + T_{II})$				$0.2 \cdot (T_I + T_{II} - 2tY)$
tc	$tu / 12$				$tY / 100$
$Pb I$	$\frac{x_{ss} \cdot 100 \%}{MBU}$	$\frac{x_{ss} \cdot T_{II} \cdot 100 \%}{MBU (T_I + T_{II})}$	$\frac{x_{ss} \cdot 200 \%}{MBU}$	$\frac{x_{ss} \cdot T_{II} \cdot 200 \%}{MBU (T_I + T_{II})}$	$\frac{x_{ss} \cdot 50 \%}{MBU}$
$Pb II$	–	$Pb I \cdot (T_I / T_{II})$	–	$Pb I \cdot (T_I / T_{II})$	–
Parameter	Two-state controller	3-state controller	Contin. controller	Split range controller	Step controller

1) If one of the times T_I or T_{II} is considerably longer than the other one, the value for t_U is too high.

Correction with limitation of the regulation ratio **YH** positive: Multiply **Pb I** by $100 \% / YH$

YH negative: Multiply **Pb II** by $-100 \% / YH$

Correction for step controller if one of the times T_I or T_{II} is smaller than **tY**:

Multiply **Pb I** by $\frac{tY \cdot tY}{T_I \cdot T_I}$, if T_I is smallest, multiply by $\frac{tY \cdot tY}{T_{II} \cdot T_{II}}$, if T_{II} is smallest

The value for **tU** is very inaccurate in this case. It should be re-optimized in control operation.

Control operation

After optimizing is ended, the controller can be used:

- Configure the desired control algorithm with **Controller type**.
- Set the **set point** to the required value.
- For three-state, split range and step controllers, the deadband can be increased from **dbnd = 0** should the control of the switching outputs I (and/or continuous output) and II change too fast due to an instable actual value.

Set point ramps

Function	The parameters SPuP / SPdn cause a gradual change in temperature (rising/falling) in degrees per minute. Activation when: <ul style="list-style-type: none">– The auxiliary voltage is turned on– An actual set point is changed– The second set point is activated– Changing from manual to automatic mode
Set point display	The default set point is shown by a flashing r in the left digit, not the actually valid value.
Limit values	Relative limit values make reference to the ramp, not the target value. For this reason, no alarm is triggered as a rule.

Heating current monitor

Function	The heating current is acquired via an external transformer (e.g. GTZ 4121). An alarm is issued when, with the heater switched on (control output I active), the current set point is fallen below by more than 20 %, or when, with the heater switched off, the current is not "off". The alarm is only cleared when, with output I active, the heating current is high enough <u>and</u> no current flows with output I inactive. The monitor is inactive if the controller is switched to oFF and with continuous and step controller.
Current set point AMPS	The nominal phase current of the heater must be entered for this parameter. For automatic setting, AMPS must be set to Auto with the heater switched on. The actually measured current is stored.

Heating circuit monitor

Function

- Active / inactive configurable with the configuration digit "Alarms" (see Configuration)
- Without external transformer, without additional parameters
- Correct optimization of the control parameters **tu** and **Pb I** is a pre-condition!
i.e. before self-optimization is started, heating circuit monitoring must be activated.
The lower limit for the **tu** parameter must be maintained for manual optimization or subsequent adjustment of the control parameters:

$$\text{minimum } tu = \frac{Pb I}{50\%} \cdot \frac{MBU}{\Delta\vartheta/\Delta t}$$

$\Delta\vartheta/\Delta t$ = maximum temperature rise during start-up

- The error message **LE** is generated after approximately 2 times **tu** if the heater remains switched on 100 % and the increase in temperature is too small
- The monitor is inactive, when
Controller type = limit monitor, positioner or step controller
During self-optimizing
With standard signal input (marking B2)
The limitation of the regulation ratio **YH** < 20 %

Limit monitor

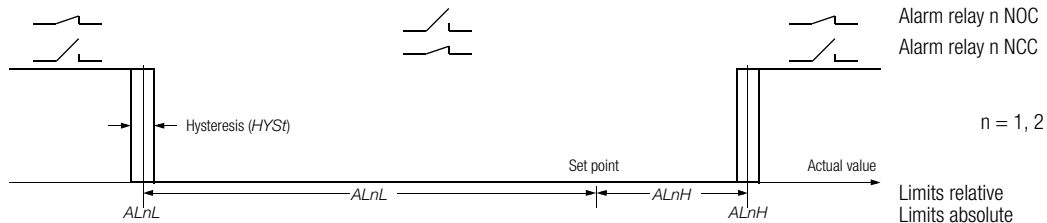

Start-up suppression: the alarm suppression at start-up is active (configuration digit "Alarms 1") until the temperature has exceeded the low limit for the first time. When cooling, the suppression is effective until the high limit has been fallen below for the first time. It is effective when: The auxiliary voltage is switched on, the actual set point is changed and the second set point is activated, as well as when changing from Off to automatic mode.

Alarms

Display (only on operating level)	Error source	Reaction	Remarks
<i>Heating current flashes</i>	Heating current monitor	Alarm output A1 active and LED A1 on	NOC/NCC defined in the configuration digits "Alarms 1 and 2". LED flashes on all levels
<i>Actual value flashes</i>	Limit monitor 1	Alarm output A1 active and LED A1 on	
<i>Actual value flashes</i>	Limit monitor 2	Alarm output A2 active and LED A2 on	

During parameter setting and/or configuration, the operating level is entered 10 s after the value setting is ended.

Error messages

Action when an error occurs:

1. Alarm output A1 is activated; configuration digit "Alarms 1" defines its action (see Configuration, page 20).
2. LED A1 flashes on all levels. Errors are only displayed (flashing) on the operating level: With incorrect measured values on the display which otherwise shows the correct value (**SE H**, **SE L**, **CE** and **YE**), the other errors are shown on the upper display.
3. During parameter setting and/or configuration, the operating level is entered 10 s after the value setting is ended.
4. See the following table for exceptions and more information.

Display		Error source	Reaction	Remedy																	
SE H	sensor error high	Sensor breakage or actual value > upper range limit	<table border="1"> <thead> <tr> <th rowspan="2">Controller type</th> <th colspan="2">Regulation ratio output</th> </tr> <tr> <th>$YSE = -100/0/100\%$</th> <th>$YSE \neq -100/0/100\%$</th> </tr> </thead> <tbody> <tr> <td>2-, 3-state</td> <td>-100/0/100%</td> <td>If controller in stable condition: Last "plausible" regulation ratio, if not: YSE</td> </tr> <tr> <td>Step</td> <td colspan="2">YSE</td> </tr> <tr> <td>Limit signal</td> <td colspan="2"></td> </tr> <tr> <td>Positioner</td> <td colspan="2">No reaction to error</td> </tr> </tbody> </table>	Controller type	Regulation ratio output		$YSE = -100/0/100\%$	$YSE \neq -100/0/100\%$	2-, 3-state	-100/0/100%	If controller in stable condition: Last "plausible" regulation ratio, if not: YSE	Step	YSE		Limit signal			Positioner	No reaction to error		1
Controller type	Regulation ratio output																				
	$YSE = -100/0/100\%$	$YSE \neq -100/0/100\%$																			
2-, 3-state	-100/0/100%	If controller in stable condition: Last "plausible" regulation ratio, if not: YSE																			
Step	YSE																				
Limit signal																					
Positioner	No reaction to error																				
SE L	sensor error low	Polarity of sensor or actual value < lower range limit																			
CE	current error	Wrong polarity of current transformer, transformer not suited or unserviceable	Same as heating current monitor alarm Continues to control	2																	
YE	y error	Position readback message beyond calibration; $Y100 \leq Y0$	<u>No</u> reaction to error	3																	

<i>no t</i>	no tune	Self-optimizing cannot be started (controller type "Positioner" or "Limit monitor")	No reaction to error Error display remains visible until a key stroke is made	–
<i>tE 2</i>	tune error 2	Disturbed optimizing run in step 1 ... 13 (here step 2)	Control outputs I and II inactive Self optimizing must be stopped	4
<i>LE</i>	loop error	Measured increase in temperature too low with the heater switched on 100 %	Control outputs I and II inactive Error message is maintained until keystroke  long	5
<i>PE</i>	parameter error	Parameter beyond permissible limits	Control outputs I + II inactive The parameter level is disabled	6
<i>dE</i>	digital error	Error recognized by monitoring of the digital unit	Control outputs I + II inactive	7
<i>AE</i>	analog error	Hardware error recognized by monitoring of the analog unit	Control outputs I + II inactive	7

Remedies

1. Eliminate sensor error.
 2. Check current transformer.
 3. Potentiometer for position readback: Check connection, re-calibrate.
 4. Avoid disturbances impairing the optimizing run, such as sensor errors.
 5. Close the control loop: Check the function of sensor, control elements and heater.
 6. Run default configuration and default parameters, and then re-configure and reset parameters, or upload user defined default setting.
 7. Repair by competent service center.
- Check correlation between sensor and heater (wiring).
Perform correct optimization of the control parameters **tu** and **Pb I**.

Technical data

Climatic suitability with reference to VDI/VDE 3540	3z / 0 / 50
Relative humidity, annual average, no condensation	75 %
Ambient temperature	
Nominal range of use	0 °C ... + 50 °C
Function range	0 °C ... + 50 °C
Storage range	-25 °C ... + 70 °C

Aux. voltage	Nominal range of use		Power consumption
	Voltage	Frequency	
AC 110 V	AC 95 V ... 121 V	48 Hz ... 62 Hz	Maximum 10 VA Typically 6 W
AC 230 V	AC 196 V ... 253 V		
AC 24 V	AC 21 V ... 26 V		
DC 24 V	DC 20 V ... 30 V	–	

Relay output	Potential-free NOC (switcher)
Switching power	AC/DC 250 V, 2 A, 500 VA / 50 W
Service life	> 2•10 ⁵ switching cycles under nominal load
Interference suppression	Provide ext. RC element (100 Ω - 47 nF) on contactor

Transistorized output suited for commercially available solid state relays (SSR)		
Switching state	No-load voltage	Output current
Active (load ≤ 800 Ω)	< DC 17 V	10 ... 15 mA
Inactive	< DC 17 V	< 0.02 mA
Overload limit	Short circuit, cont. interruption	
Electrical safety		
Protection class	II, mounting equipment in the sense of DIN EN 61010-1 clause 6.5.4	
Pollution degree	1, acc. to DIN EN 61010-1 clause 3.7.3.1 and/or IEC 664	
Overvoltage category	II, acc. to DIN EN 61010 appendix J and/or IEC 664	
Working voltage	300 V acc. to DIN EN 61010	
EMC generic emission	DIN EN 50081-2	
EMC generic immunity	DIN EN 50082-2	

See Data Sheet, Ordering No. 3-348-797-03 for complete technical data

Printed in Germany • Subject to change without notice

GOSSEN-METRAWATT GMBH
Thomas-Mann-Str. 16-20
90471 Nuremberg, Germany

Phone +49 911 8602-0
Fax +49 911 8602-669
e-mail: info@gmc-instruments.com
<http://www.gmc-instruments.com>

GOSSEN
METRAWATT
CAMILLE BAUER